

SPECIFICATION FOR APPROVAL

MODEL:FEH112



Applications

Factory, gym, dock, billboard, building, tunnel, landscape, city lighting projects

Features

- ◆ The light source adopts the integration of imported single high power LED, with the special design of integrating many chips into one lighting source.
- ◆ The crust in aluminum alloy die casting ensures the efficiency of heat emission, guaranteeing the light a long life span.
- ◆ The high pure imported aluminum from Germany as the reflector has high reflecting efficiency, and it can make sure the luminous flux, controlling the light inside of a useful area. It improves the efficiency of light uniformity and utilization, showing the LED advantage of energy saving.
- ◆ The integration of 5mm high strength roughened glass and the housing makes the light work perfectly in the high humidity environments.
- ◆ New high efficiency constant current driver. Wide range of input voltage: AC100-240V.
- ◆ No delay start. No waiting. It can reach its normal light as soon as it is turned on. No noise.
- ◆ No electrical wave, conforming to CE.
- ◆ Environment friendly and no air pollution. We exert the design of using cold light source. It's no heat radiation. There is no ill to our eyes and skin. The floodlights do not have lead, hydrargyrum and any other contamination. It is really environment friendly with ROHS certificate

Parameter

MAIN SPECIFICATIONS (T=25°C)		
NUMBER	ITEM	DESCRIPTION
01	Input Voltage	AC100-240V 47-63Hz
02	LED	1pc
03	Power	100W
04	LED Efficiency	80-90Lm/W
05	Initial Flux	>9000Lm (Cool White) >8700Lm (Natural White) >8300Lm (warm white)
06	Power factor	>0.95
07	Color	Warm White /Natural White / Cool White/Red/Green/Blue/Yellow
08	Color Temperature	2700-3300K (Warm White) 4000-5000K (Natural White) 5300-7000K (Cool White)
09	Center Illuminance	1.5M: 1482 Lux 3.0M: 370 Lux 6.0M: 94 Lux
10	Beam Angle	120°
11	Life Time	>50,000 Hour
12	Operating Temperature	-25°C to +55°C
13	Storage Temperature	-40°C to +65°C
14	Connect Wire	Brown L Blue N Yellow/Green G
15	Certifications	CE, RoHS
16	Weight	8.35Kg
17	Size	434×332×128mm
18	IP Code	IP65

Light distribution graph

Distribution Curve of Meridian

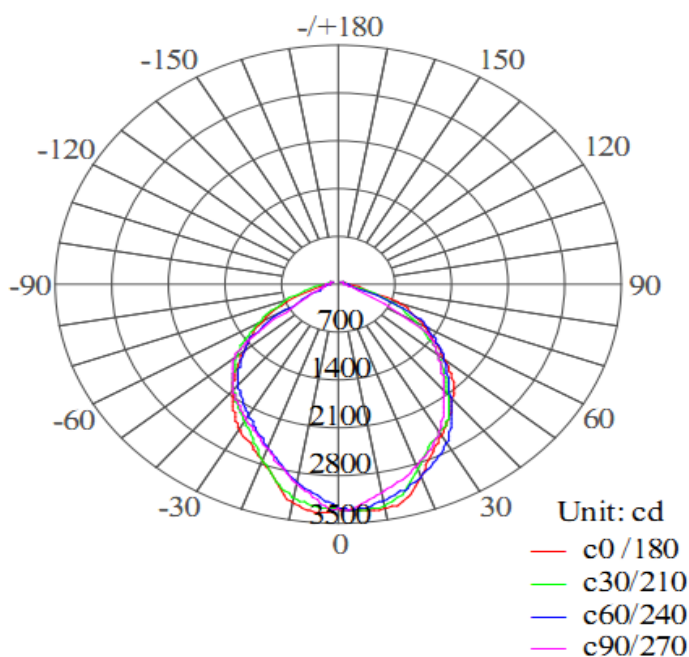

Illumination intensity chart

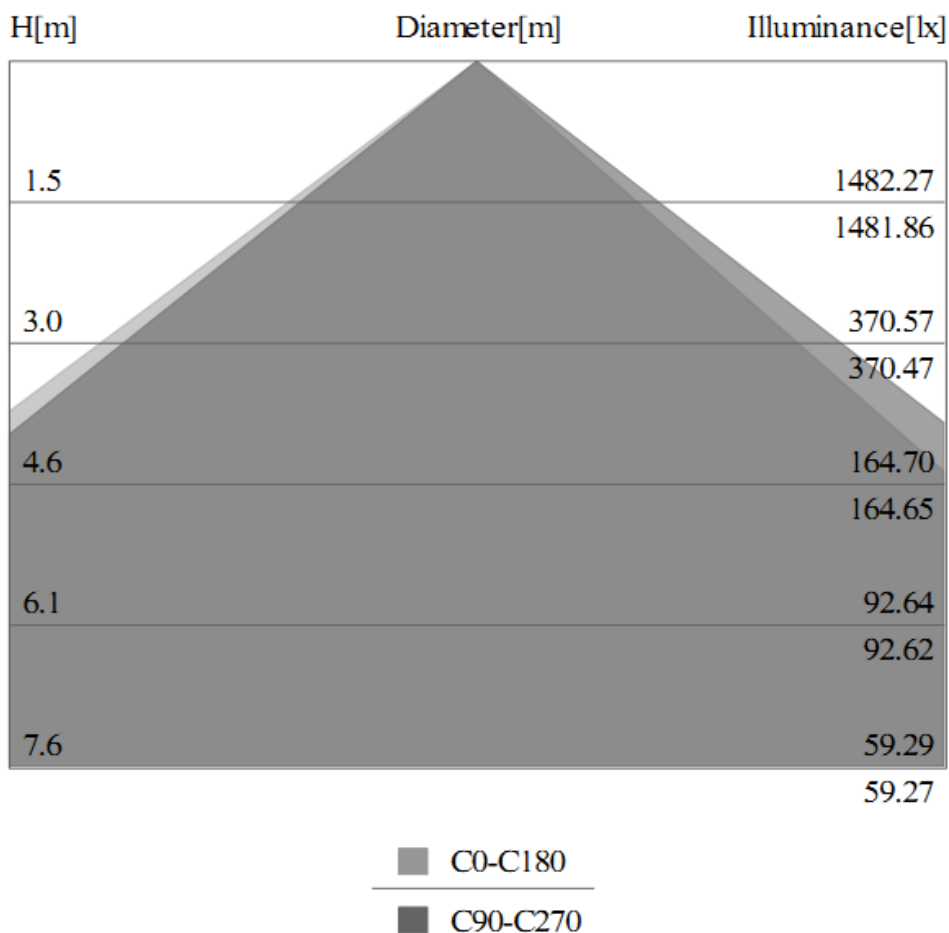

LED Lumen Attenuation LED

Operating time(hours)	Lumen decrease(%)
5,000	2.4
10,000	5.2
20,000	11.3
50,000	24.5

Dimensions

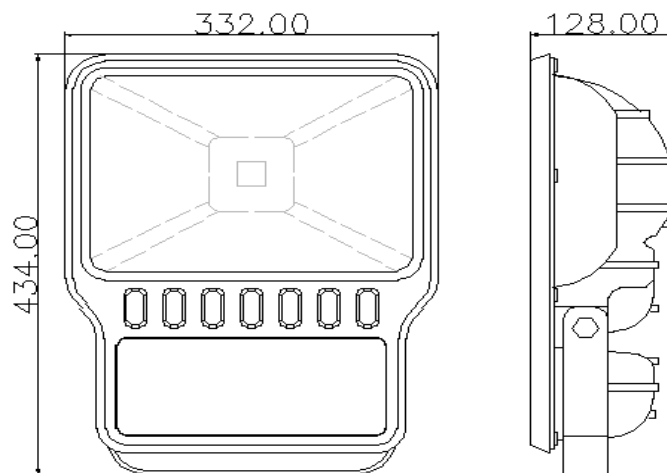

Notes

1. All dimension units are millimeters.
2. All dimension tolerance is $\pm 0.5\text{mm}$ unless otherwise noted.

Packing

Inner Carton: 376×171×475mm (1pcs/ctn) G.W:8.5 Kg

Outer Carton: 386×352×485mm (2pcs/ctn) G.W:17.3 Kg

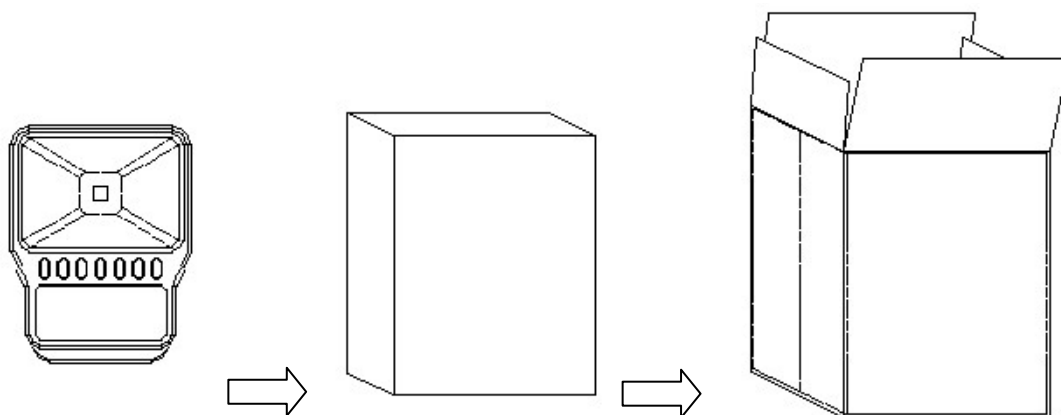

Safety Notice for Using

- ◆ Please always use the light out of its package.
- ◆ Before starting use of the light, please check if the light was damaged during transportation. If any damage shown, please DO not install or use it.
- ◆ Any maintenance should be performed by trained professionals only.
- ◆ Keep packaging materials away from the reach of children and pets. Risks of suffocation!
- ◆ Caution. The packaging contains small parts that may be swallowed by children.
- ◆ Never leave children unattended in the vicinity of the lights and do not allow them to play with electrical devices.
- ◆ Try to avoid looking directly in the LED beam-especially for extended periods of time. Do not shine the LED light in another person's eyes.
- ◆ Never cover the light by other objects.
- ◆ The products need to re-repair, inspection or special treatment of retirement after service time.

Maintenance

- ◆ Prior to cleaning the light, make sure it has been disconnected from the power supply.
- ◆ Use a dry or slightly moistened cloth for cleaning.
- ◆ Never use any chemicals or abrasives for cleaning.

Proposal :

Used electronic devices must be collected for recycling and can not be deposited together with daily garbage.

Installation

- ◆ This product should be installed by trained electricians.
- ◆ Check integrity of the products when unpack the packing.
- ◆ When laying the cables, make sure that the cables and plugs are not subjected to any tensile or twisting forces. Fit the cable tension relieving mechanisms to the connection points of the surface-mounted lights. Do not kink cables. Output cables should be laid separately and at a distance from other cables.
- ◆ Proceed by connecting the wiring cables to the luminaries. Usually, the brown(or black) wire is the live wire, connect it with the terminal marked "L". The blue wire is Naughty wire, connect it with the terminal marked "N".
- ◆ Used only the LED driver included, and do not connect the surface-mounted lights to other loads.
- ◆ Do not remove the name plate of the power supply and driver of the light.

Notes

Non-professionals are not allowed to disassemble and maintain the products. We have the right not to provide after-sale service if unauthorized disassembly and maintenance happens to the products.